

Load Frequency Controllers Design and Comparison for Inter Connected Hydro-Thermal Systems

Srikanth Babu V¹, Aivelu Sondi²

Assistant Professor, Department of Electrical Engineering, GMR Institute of Technology, Rajam, AP, India¹

P.G. Student, Department of Electrical Engineering, GMR Institute of Technology, Rajam, AP, India²

ABSTRACT: For interconnection of two or more areas in power system, frequency should be maintained within the scheduled value, which can be achieved by employing one of the most prominent techniques called as Automatic Load Frequency Control (ALFC). In ALFC, the frequency can be controlled in three ways, namely Flat frequency regulation, Parallel frequency regulation and Flat tie-line loading. Among these controls in this paper, Parallel frequency regulation is commonly used method because constant frequency can be maintained by equalizing the power generation with the power demand. The main aim is to reduce the oscillations or damping in the frequency and also the changes in tie-line power. In this paper, PI and PID controllers are used to improve both frequency and tie-line power responses for multi-area interconnected power system (which consists of Hydro-thermal generating system). This issue is resolved by implementing a novel controller called Sliding Mode Controller (SMC) and compared with the conventional controllers. The proposed system is designed and simulated in MATLAB/SIMULINK.

KEYWORDS: LFC, reheat turbine, PI Controller, SMC, switching surface, MATLAB/SIMULINK.

I. INTRODUCTION

LFC problem arises when individual generation areas are interconnected by transmission lines called as tie-lines. The main objectives LFC are i) to maintain constant frequency throughout the system, ii) to preserve the tie-line power at a scheduled level irrespective of load changes in any area, iii) to diminish Area Control Error (ACE) and IV) to minimize Peak time, Peak overshoot and settling time. When interconnecting two or more areas/regions for providing continuous supply, the complexity of the system increases. Due to the increased complexity of modern power systems, advanced control methods were proposed in ALFC. The most important features of two utility interconnected (multi-area) system is that to buy or sell power with neighbouring systems, to meet sudden requirement of power demand, to reduce the installed capacity, to possess higher reliability with better quality of supply. The Modelling and the simulation of two area Hydro-thermal interconnected power systems [9] are realized in MATLAB Software. This paper is organised as follows, section-I explains about the introduction of Load frequency control. Section-II briefly describes the proposed work. Section-III illustrates about different control strategies such as conventional controllers, SMC technique. Section-IV briefly describes about the system design. Section-V shows you the results with comparison of important specifications such as Peak overshoot, settling time, steady state error, etc. of frequency of each area and tie-line power.

II. PROPOSED WORK

The power generation involves with renewable and non-renewable sources i.e. thermal, nuclear, hydro, gas, wind, solar etc. Among these nuclear, thermal and hydro power systems play a major role in the interconnected power system. Gas, wind and solar power system are in evolution stage so these systems are less emphasized, where nuclear operating to its maximum efficiency at maximum load there will not be much impact on the interconnected system. So thermal and hydro systems are more taken care. In this regard several research works is pursued in the past. Initially the problem of ALFC is approached by proportional controllers, later on P, PI and PID controllers are used.

International Journal of Innovative Research in Science, Engineering and Technology

(An ISO 3297: 2007 Certified Organization)

Website: www.ijirset.com

Vol. 6, Issue 8, August 2017

$$\sigma_i(t) = G_i x_i - \int_0^t G_i (A_i' - B_i' k_i) x_i(\tau) d\tau \quad (1)$$

The *ith* area of interconnected power system block diagram is as shown below,

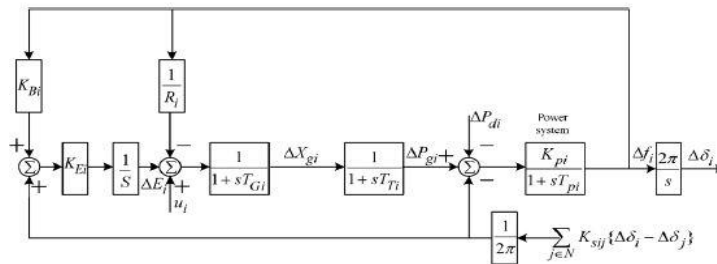

Fig.2. *ith* Area of inter connected power system block diagram.

From the *ith* area of interconnected power system the below dynamic equations are obtained.

$$\Delta F_i(t) = -\frac{1}{t_{p_i}} \Delta F_i(t) + \frac{k_{p_i}}{t_{p_i}} \Delta p_{g_i}(t) - \frac{k_{p_i}}{t_{p_i}} \Delta p_{d_i}(t) - \frac{k_{p_i}}{2\pi t_{p_i}} \sum_{\substack{j \in N \\ j \neq i}} k_{sij} \{ \Delta \delta_i(t) - \Delta \delta_j(t) \} \quad (2)$$

$$\Delta p_{g_i}(t) = -\frac{1}{T_i} \Delta p_{g_i}(t) + \frac{1}{T_i} \Delta x_{g_i}(t) \quad (3)$$

$$\Delta x_{g_i}(t) = -\frac{1}{R_i t_{g_i}} \Delta F_i(t) - \frac{1}{t_{g_i}} \Delta x_{g_i}(t) - \frac{1}{t_{g_i}} \Delta e_i(t) + \frac{1}{t_{g_i}} u_i(t) \quad (4)$$

$$\Delta e_i(t) = k_{e_i} \left[k_{b_i} \Delta F_i(t) + \frac{1}{2\pi} \sum_{\substack{j \in N \\ j \neq i}} k_{sij} \{ \Delta \delta_i(t) - \Delta \delta_j(t) \} \right] \quad (5)$$

$$\Delta \delta_i(t) = 2\pi \Delta F_i(t) \quad (6)$$

Where $i=1 \dots N$ and N is the number of areas. From the above equations (2)...(6) The below matrix form obtained.

$$X_i(T) = a_i X_i(T) + b_i U_i(T) + \sum_{\substack{J \in N \\ J \neq i}} e_{ij} X_j(T) + f_i \Delta p_{d_i}(T) \quad (7)$$

$$a_i = \begin{bmatrix} -\frac{1}{t_{p_i}} & \frac{k_{p_i}}{t_{p_i}} & 0 & 0 & -\frac{k_{p_i}}{2\pi t_{p_i}} \sum_{j \neq i} k_{sij} \\ 0 & -\frac{1}{t_i} & \frac{1}{t_i} & 0 & 0 \\ -\frac{1}{R_i t_{g_i}} & 0 & -\frac{1}{t_{g_i}} & -\frac{1}{t_{g_i}} & 0 \\ k_{e_i} k_{b_i} & 0 & 0 & 0 & \frac{k_{e_i}}{2\pi} \sum_{j \neq i} k_{sij} \\ 2\pi & 0 & 0 & 0 & 0 \end{bmatrix}; \quad b_i = \begin{bmatrix} 0 & 0 & \frac{1}{t_{g_i}} & 0 & 0 \end{bmatrix}; \quad f_i = \begin{bmatrix} -\frac{k_{p_i}}{t_{p_i}} & 0 & 0 & 0 & 0 \end{bmatrix}^T; \quad g_i = \begin{bmatrix} 0 & 0 & \frac{1}{13.021} & 0 & 0 \end{bmatrix}$$

International Journal of Innovative Research in Science, Engineering and Technology

(An ISO 3297: 2007 Certified Organization)

Website: www.ijirset.com

Vol. 6, Issue 8, August 2017

$$e_{ij} = \begin{bmatrix} 0 & 0 & 0 & 0 & \frac{k_p}{2\Pi T_p} k_{sij} \\ 0 & 0 & 0 & 0 & 0 \\ 0 & 0 & 0 & 0 & 0 \\ 0 & 0 & 0 & 0 & -\frac{k_{ei}}{2\Pi} k_{sij} \\ 0 & 0 & 0 & 0 & 0 \end{bmatrix}; \quad X_i(T) = \begin{bmatrix} \Delta F_i(t) \\ \Delta p_{g_i}(t) \\ \Delta x_{g_i}(t) \\ \Delta e_i(t) \\ \Delta \delta_i(t) \end{bmatrix}; \quad k_1 = [1.4988 \quad 1.9918 \quad 0.6374 \quad 0.7199 \quad 0.1481]$$

The variables $\Delta f_i(t)$, $\Delta p_{g_i}(t)$, $\Delta x_{g_i}(t)$, $\Delta e_i(t)$ and $\Delta \delta_i(t)$ are the frequency changes in the system, output power, position valve of governor, integral control and deviation of rotor angle respectively. The matrices g_1 , k_1 are the constant matrices. Finally the equation (1) i.e. sliding surface is derived from the above matrices. Based on the following assumptions, the sliding mode load frequency control and the sliding surface for each area are designed.

Assumption 1: Two matrices in the systems are controlled fully i.e. A_i' & B_i'

Assumption 2: The condition mentioned below is true

$$g_i(t) = B_i' g_i'(t) \quad (8)$$

Assumption 3: $rank[B_i', g_i'(t)] \neq rank[B_i']$

Assumption 4: $\|g_i(t)\| \leq h_i$ where $\|\cdot\|$ is matrix norm and positive constant is denoted as h_i

3.2 Design of equivalent Control law:

The corresponding reachability condition of each area is described as for an interconnected power system.

$$\sum_{i=1}^n \frac{\sigma_i^T(t) \dot{\sigma}_i(t)}{\|\sigma_i(t)\|} < 0 \quad (9)$$

Based on assumptions 1 and 2, the equivalent control law can be designed to guarantee the hitting condition (9) will be satisfied:

$$u_i(t) = k_i x_i - (G_i B_i')^{-1} \|G_i\| c_i \|x_i(t)\| \operatorname{sgn}(\sigma_i(t)) - d_i - (G_i B_i')^{-1} \lambda_i \operatorname{sgn}(\sigma_i(t)) \quad (10)$$

Where $\lambda_i \triangleright 0$, and

$$\operatorname{sgn}(\sigma_i(t)) = \begin{cases} 1 & \text{if } \sigma_i(t) \triangleright 0 \\ 0 & \text{if } \sigma_i(t) = 0 \\ -1 & \text{if } \sigma_i(t) < 0 \end{cases} \quad (11)$$

Based on assumptions 4 and 5, the equivalent control law (12) is designed to guarantee the hitting condition is satisfied:

$$u_i(t) = k_i x_i - (G_i B_i')^{-1} \|G_i\| c_i \|x_i(t)\| \operatorname{sgn}(\sigma_i(t)) - (G_i B_i')^{-1} \|G_i\| h_i - (G_i B_i')^{-1} \lambda_i \operatorname{sgn}(\sigma_i(t)) \quad (12)$$

IV. SYSTEM DESIGN

Here the system design consists of the two area hydro thermal system of LFC. The system of automatic generation control (AGC) consists of two generating areas of equal size, area 1 comprising a reheat thermal system and area 2 comprising a hydro system. The figure.3 shows the model of two area hydro thermal system. The thermal system consists of mechanical governor, single stage reheated turbine and power system. The hydro system consists of

International Journal of Innovative Research in Science, Engineering and Technology

(An ISO 3297: 2007 Certified Organization)

Website: www.ijirset.com

Vol. 6, Issue 8, August 2017

electrical governor, hydro turbine and power system. A bias setting considered for both hydro and thermal areas is $B_i = \beta_i$. The linearized transfer function model is proposed in the system as shown in the fig.3. Each and every area has its own parameters. In order to control the area error by controller is known as area control error (ACE). This is given in equations are shown below

$$ACE_1 = \Delta P_{tie1-2} + B_1 \Delta f_1 \tag{13}$$

$$ACE_2 = \Delta P_{tie2-1} + B_2 \Delta f_2 \tag{14}$$

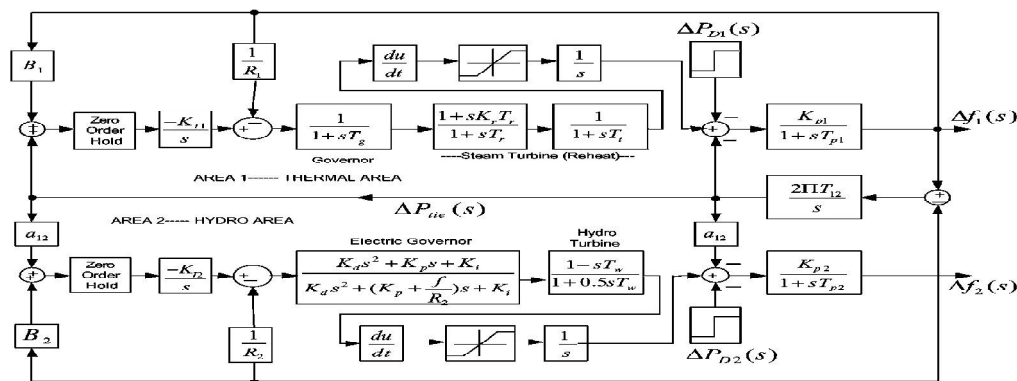

Fig.3. Simulink model of an inter connected two area hydro-thermal System with PI controller.

The tie line power deviation in area1 is ΔP_{tie1-2} and the tie line power deviation in area2 is ΔP_{tie2-1} . B_1 and B_2 are frequency bias constants of two areas. Δf_1 , Δf_2 are the frequency change in area1 and area2 respectively. The dynamic responses Δf_1 , Δf_2 , ΔP_{tie} for 1% step load perturbation in either area. System data has been taken from [10] and [11]. The optimum values of derivative, proportional and integral gains for the electric governor have been taken from [6]. For the system analysis, 1% step load perturbation has been considered either in thermal or hydro area. The controllers in both areas have been optimized using integral square error (ISE) criterion. For ISE technique, the objective function used is

$$J = \sum_{n=0}^{2000} \left[\Delta P_{tie}^2 + \Delta f_1^2 + \Delta f_2^2 \right] \Delta T \tag{15}$$

Where ΔT = interval during sample for short period (0.1 sec),
 n = iteration count,
 ΔP_{tie} = tie power incremental change,
 Δf = frequency incremental change.

V. RESULT AND DISCUSSION

In this paper, Hydro -Thermal interconnected power system is considered. The parameters for the propose system is obtained from the reference paper [10] and the Simulink model is shown in Figure-3. The frequency deviation Δf_1 , Δf_2 and change in tie line power ($\Delta P_{1tie-line}$) plots of Hydro -Thermal system for 1% step load increase in the thermal and hydro system are observed simultaneously. The results of two area interconnected hydrothermal power systems are clearly analysed.

Here the time taken to reach steady state value is in the order of seconds, because in thermal and hydro power systems consists mechanical equipment's which has more time constants when compared with the electrical devices. The

International Journal of Innovative Research in Science, Engineering and Technology

(An ISO 3297: 2007 Certified Organization)

Website: www.ijirset.com

Vol. 6, Issue 8, August 2017

comparison among these parameters with 1% SLP in thermal area in quantitatively has shown in table.1 using PI, PID and SMC controllers. In the table.1 the peak overshoot is reduces from 0.52 to 0.09. Here the Settling time in PI controller is150 sec, in PID controller is 110 sec and in SMC controller is 90sec. The variation in the delay time of these controllers is 5sec in PI controller, 2sec in PID controller and 1sec in SMC controller and the rise time is in PI controller is 4.5sec, in PID controller is 4.9sec and in SMC controller is 3.2sec.The peak times of these controllers is 10sec in PI controller, 6sec in PID controller and 3sec in SMC controller.

The comparison among these parameterswith 1% SLP in hydro area in quantitatively has shown in table.2 using PI, PID and SMC controllers. In the table.2 the peak overshoot is reduced from 0.25 to 0.06.Here the Settling time in PI controller is140 sec, in PID controller is 100 sec and in SMC controller is 40sec. The variation in the delay time of these controllers is 9sec in PI controller, 5sec in PID controller and 3sec in SMC controller.And the rise time is in PI controller is 5.6sec, in PID controller is 2.9sec and in SMC controller is 3sec. and the peak times of these controllers is 12sec in PI controller, 7sec in PID controller and 4sec in SMC controller.

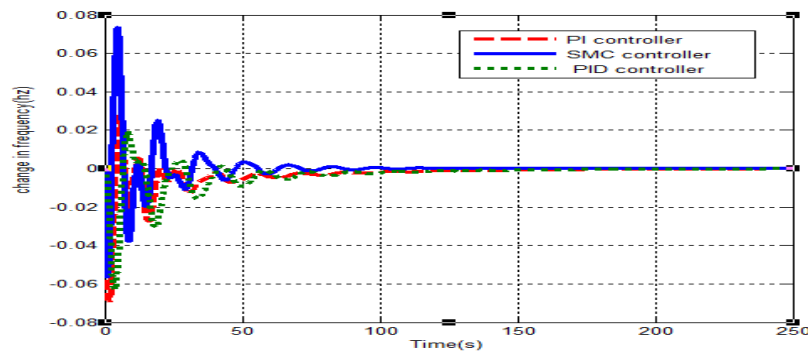

(a)

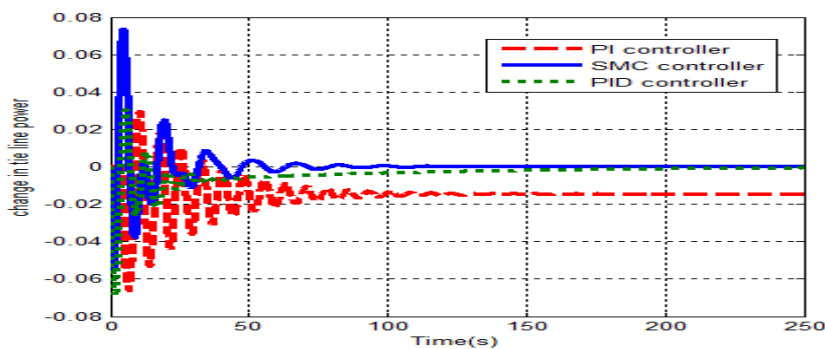

(b)

International Journal of Innovative Research in Science, Engineering and Technology

(An ISO 3297: 2007 Certified Organization)

Website: www.ijirset.com

Vol. 6, Issue 8, August 2017

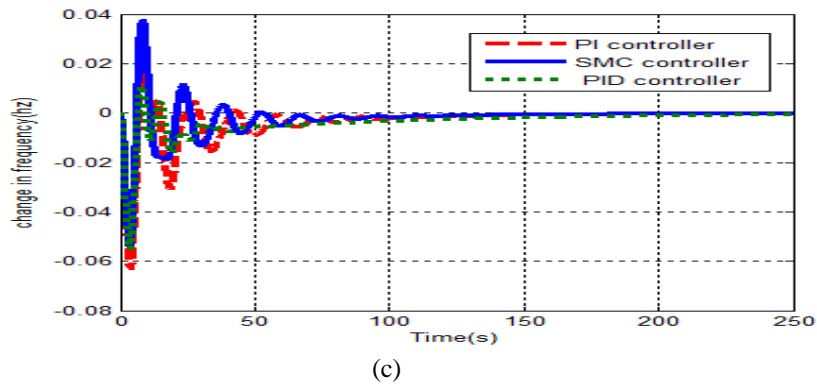
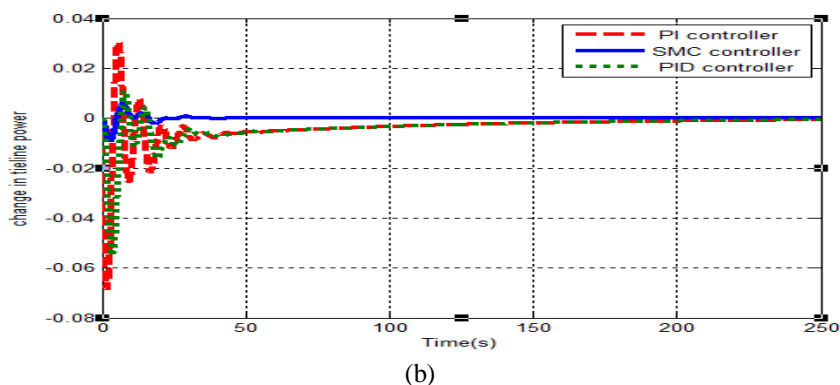
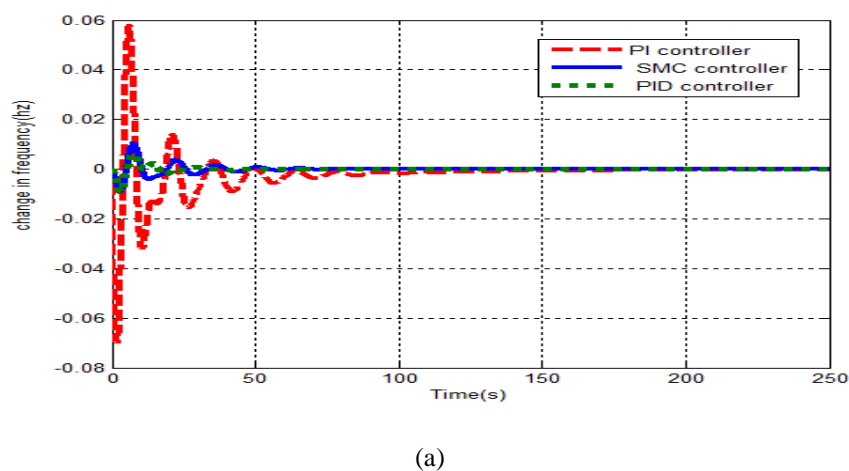

Fig.4. Comparison of PI, PID and SMC responses with 1% SLP in thermal area, (a) Δf_1 , (b) $\Delta P_{tie-line}$, (c) Δf_2

Hence, it can be concluded that the optimized control strategy, SMC controller provides best control under wide variations in the loading condition of the system.



International Journal of Innovative Research in Science, Engineering and Technology

(An ISO 3297: 2007 Certified Organization)

Website: www.ijirset.com

Vol. 6, Issue 8, August 2017

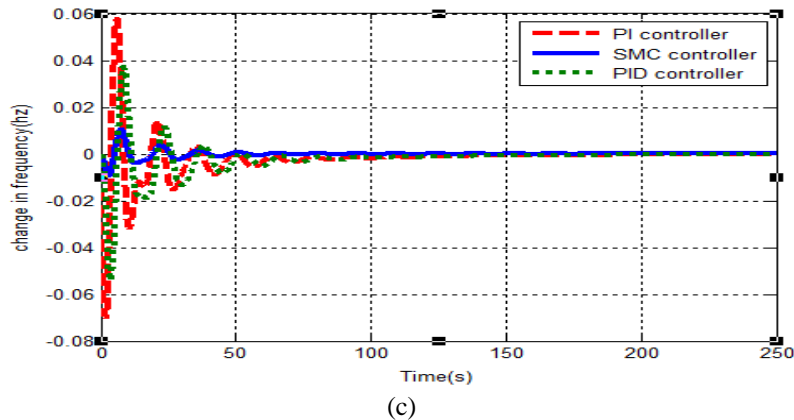

Fig.5. Comparison of PI, PID and SMC responses with 1% SLP in hydro area, (a) Δf_1 , (b) $\Delta P_{tie-line}$, (c) Δf_2

Table.1. Comparison of time response specifications for two area systems ALFC with 1% SLP in thermal area

controller	Rise Time(s)	Setting Time(s)	Peak Over Shoot(%)	Delay Time(s)	Peak Time(s)
PI	4.5	150	52%	5	10
PID	4.9	110	32.50%	2	6
SMC	3.2	90	9%	1	3

Table.2. Comparison of time response specifications for two area systems ALFC with 1% SLP in hydro area

controller	Rise Time(s)	Setting Time(s)	Peak Over Shoot (%)	Delay Time(s)	Peak Time(s)
PI	5.6	140	25%	9	12
PID	2.9	100	18%	5	7
SMC	3	40	6%	3	4

VI. CONCLUSION

In hydrothermal system, continuous-discrete mode strategy is used for hydro area to consider electric governor, reheat turbine in thermal area and for both the areas the appropriate GRC is considered. In order to obtain less peak overshoot, settling time and the system should give dynamic responses in this paper, multi-area interconnected power systems with matched and unmatched uncertainties, a novel decentralized SMLFC with PI switching surface is designed. It has been observed that from the simulation results the SMC response is far better than PI and PID controllers. In future this can be extended by interconnecting renewable sources.

REFERENCES

- [1] Engineering, E., Pradesh, A., Engineering, E., & Pradesh, A. Decentralised Sliding Mode Load Frequency Control for an Interconnected Power System with Uncertainties and Nonlinearities, 425–431.(2016).
- [2] Urfi, M., & Prashar, S. A Comprehensive Literature Review on Load Frequency Control Strategies, 5(11).(2016).
- [3] Dubey, A., & Bondriya, P. LITERATURE SURVEY ON LOAD FREQUENCY CONTROLLER, 1–8.(2016).
- [4] Naidu, P. G., & Rao, R. G. LOAD FREQUENCY CONTROL FOR A TWO-AREA INTERCONNECTED POWER SYSTEM BY USING SLIDING MODE, (10), 11–18.(2016).

International Journal of Innovative Research in Science, Engineering and Technology

(An ISO 3297: 2007 Certified Organization)

Website: www.ijirset.com

Vol. 6, Issue 8, August 2017

- [5] Kumar, R. P., &Aravindan, P. ANALYSIS OF TWO AREA LOAD FREQUENCY CONTROL EMPLOYING DIFFERENT COMPUTATIONAL METHODS, 476–484.(2015).
- [6] Science, C., & Engineering, S. Sensitivity Analysis of Multi-Area Hybrid Power System Integrated with Integral Controllers, 3(11), 547–553.(2013).
- [7] Petrovi, I., Vrdoljak, K., &Peri,N. Sliding mode based load-frequency control in power systems, 80, 514–527. <https://doi.org/10.1016/j.epsr.2009.10.026> (2010).
- [8] Vrdoljak, K., Member, S., Radošević, T., Member, S., & Perić, N. (2009). Krešimir Vrdoljak, 525–532.
- [9] Nanda, J., Mangla, A., &Suri, S. Some New Findings on Automatic Generation Control of an Interconnected Hydrothermal System With Conventional Controllers, 21(1), 187–194.(2006).
- [10] Fosha, E. Megawatt-Frequency Control Multi area Electric Energy Systems Tif * DW, (4), 556–563.(1970).
- [11] Nain, V., & Gautam, G. (n.d.). HYDRO-THERMAL SYSTEM CONSIDERING DOUBLE REHEAT TURBINE AND MECHANICAL GOVERNOR, 369–373.